

LIQUID SOAP DISPENSER WP105



148 x 148 x 120 mm

1000 ml soap tank

- Liquid soap dispenser in robust, germ-reducing and easy-care stainless steel (AISI 316L).
- All-stainless steel housing; all corners fully welded, visible surfaces satin finished and brushed. Further available surfaces: see below.
- One-hand operated and non-drip soap pump with 1000 ml tank and pressure valve in brass.
- Tank with large, lockable refill opening.
- Designed for standard liquid soaps.
- Accessible for refilling through lockable, removable front panel with fall protection.
- Keyed alike cylinder lock in corrosion-resistant zinc die-casting.
- Wear parts can be replaced as modules.
- Mounting: With four screws through key holes and one optional anti-theft hole in the back wall.
- Delivery includes fixing material.
- Weight, including single package: 2.0 kg



Suggested text for specifications:

Liquid soap dispenser in stainless steel (AISI 316L) for surface mounting. All-stainless steel housing; all corners fully welded, visible surfaces satin finished and brushed. One-hand operated and non-drip soap pump with 1000 ml tank and pressure valve in brass. Designed for standard liquid soaps. Accessible for refilling through lockable, removable front panel with fall protection. Keyed alike cylinder lock in corrosion-resistant zinc die-casting. Delivery includes fixing material.

Dimensions: 148 x 148 x 120 mm

Article No. WP105

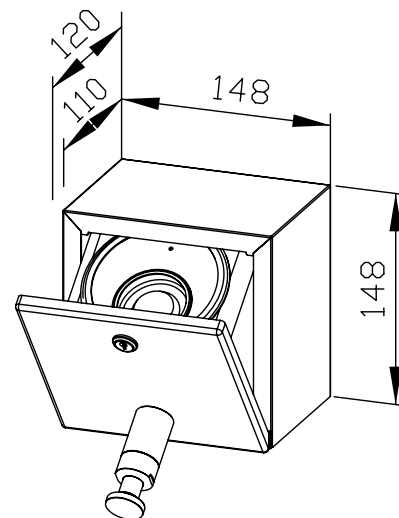

Available surfaces	ID No.
satin finished (standard)	727 599
highly polished	731 599
(coloured) plastic powder-coating	728 110

Ernst Wagner GmbH & Co. KG

Ernst-Abbe-Straße 21 · D-72770 Reutlingen · Tel.: +49712151539-0 · Fax: -20
info@wagner-ewar.de · www.wagner-ewar.de

WAGNER
EWAR