

# BASIN TAP WA200



Ø 52 x 171 x 155 mm

## Low pressure

- Single-lever basin tap without waste fitting in robust, germ-reducing and easy-care stainless steel (AISI 303).
- Version: low pressure, suitable for unpressurised tanks. Operating pressure 2–6 bar.
- Solid stainless steel body; visible surfaces satin finished. Further available surfaces: see below.
- High quality ceramic mixer cartridge with adjustable temperature limit setting (scald protection).
- Neoperl® air bubble spray M21 x 1 mm.
- Design height: 171 mm  
Outlet height: 87 mm  
Projection: 98 mm  
Length of lever: 40 mm
- Wear parts can be replaced as modules.
- Installation dimensions: Ø 33-40 mm  
Surface thickness max. 40 mm
- Mounting: With one counternut.
- Delivery includes fixing material and three flexible connecting hoses clad in stainless steel.
- Weight, including single package: 1.4 kg



### Suggested text for specifications:

Single-lever basin tap in stainless steel (AISI 303) for counter mounting. Version: low pressure. Solid stainless steel body; visible surfaces satin finished. Ceramic mixer cartridge with adjustable temperature limit setting. Delivery includes fixing material and three flexible connecting hoses clad in stainless steel.

Dimensions: Ø 52 x 171 x 155 mm

Outlet height 87 mm

Projection 98 mm

Length of lever 40 mm

Article No. WA200

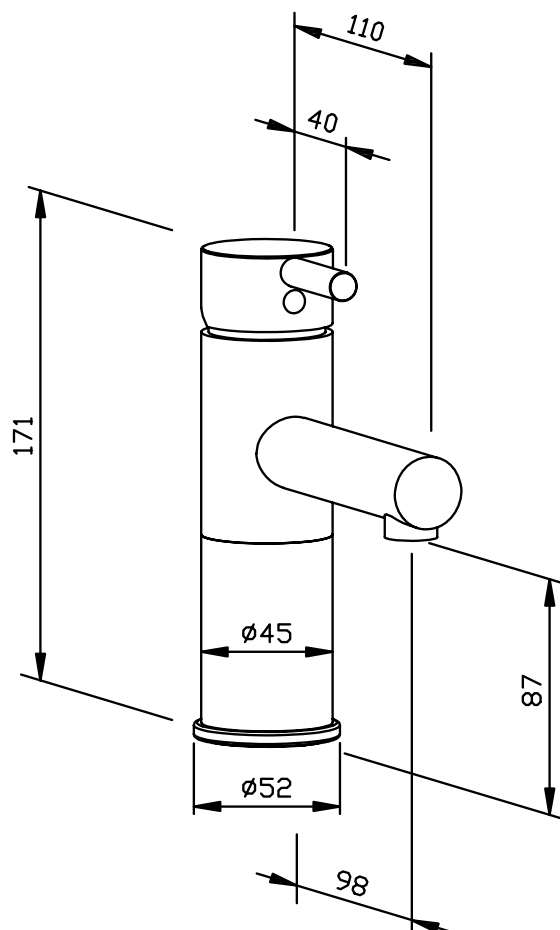

### Available surfaces

### ID No.

satin finished (standard)

924 267

highly polished

931 267

### Ernst Wagner GmbH & Co. KG

Ernst-Abbe-Straße 21 · D-72770 Reutlingen · Tel.: +49712151539-0 · Fax: -20  
info@wagner-ewar.de · www.wagner-ewar.de

WAGNER  
EWAR